

SINGER

410W111

SINGER**

410wIII



** A TRADE MARK OF

THE SINGER MANUFACTURING COMPANY

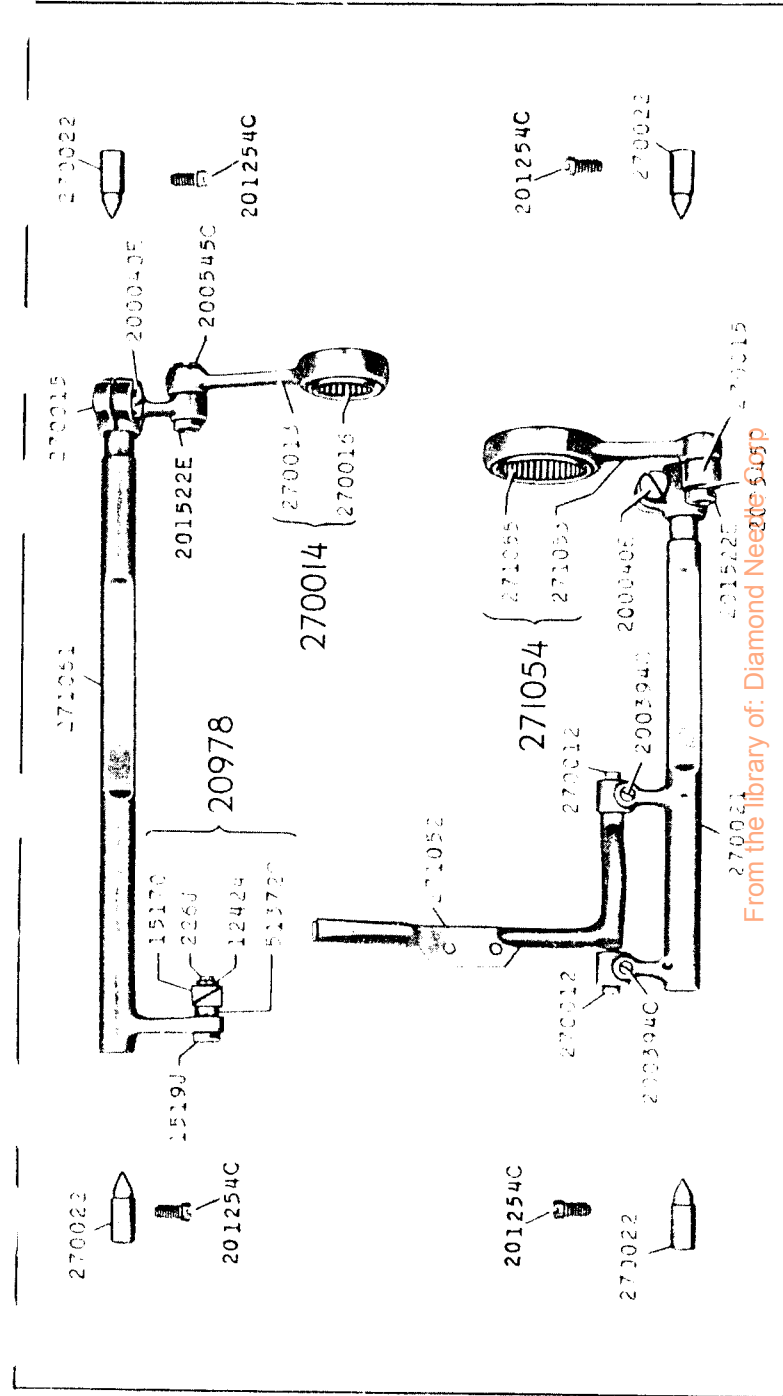

From the library of: Diamond Needle Co. 5145P

18299 - 1/2

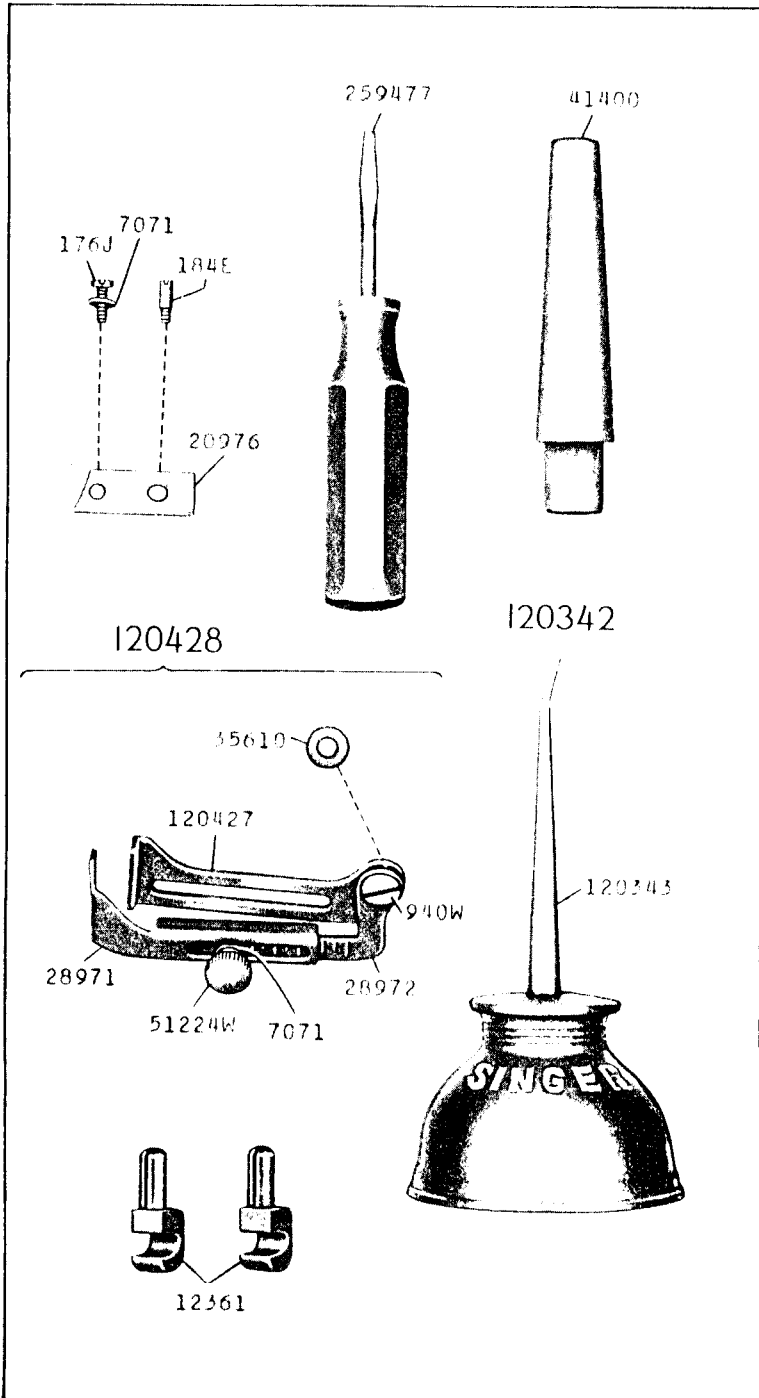

18333 - 1/4

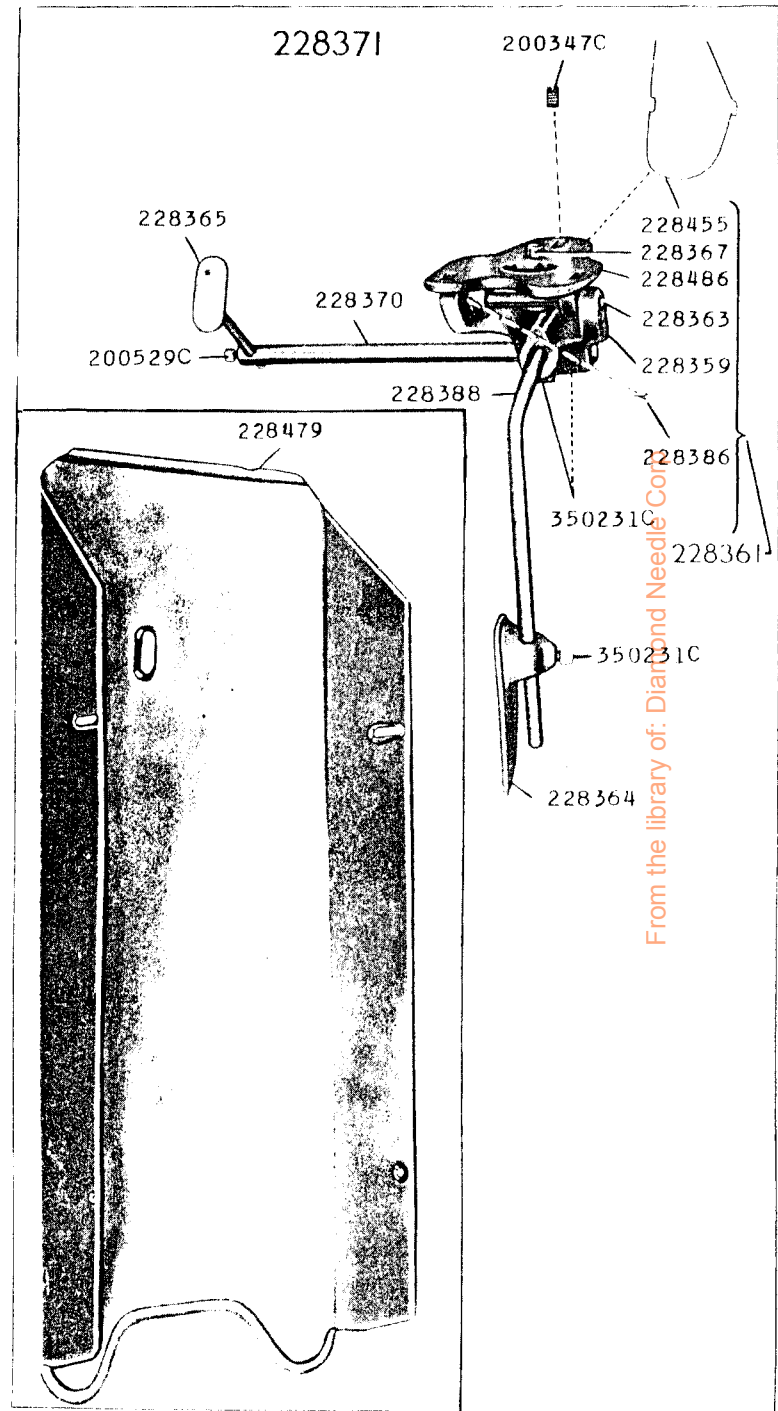

From the library of: Diamond Needle Co.

18457 - 1/2

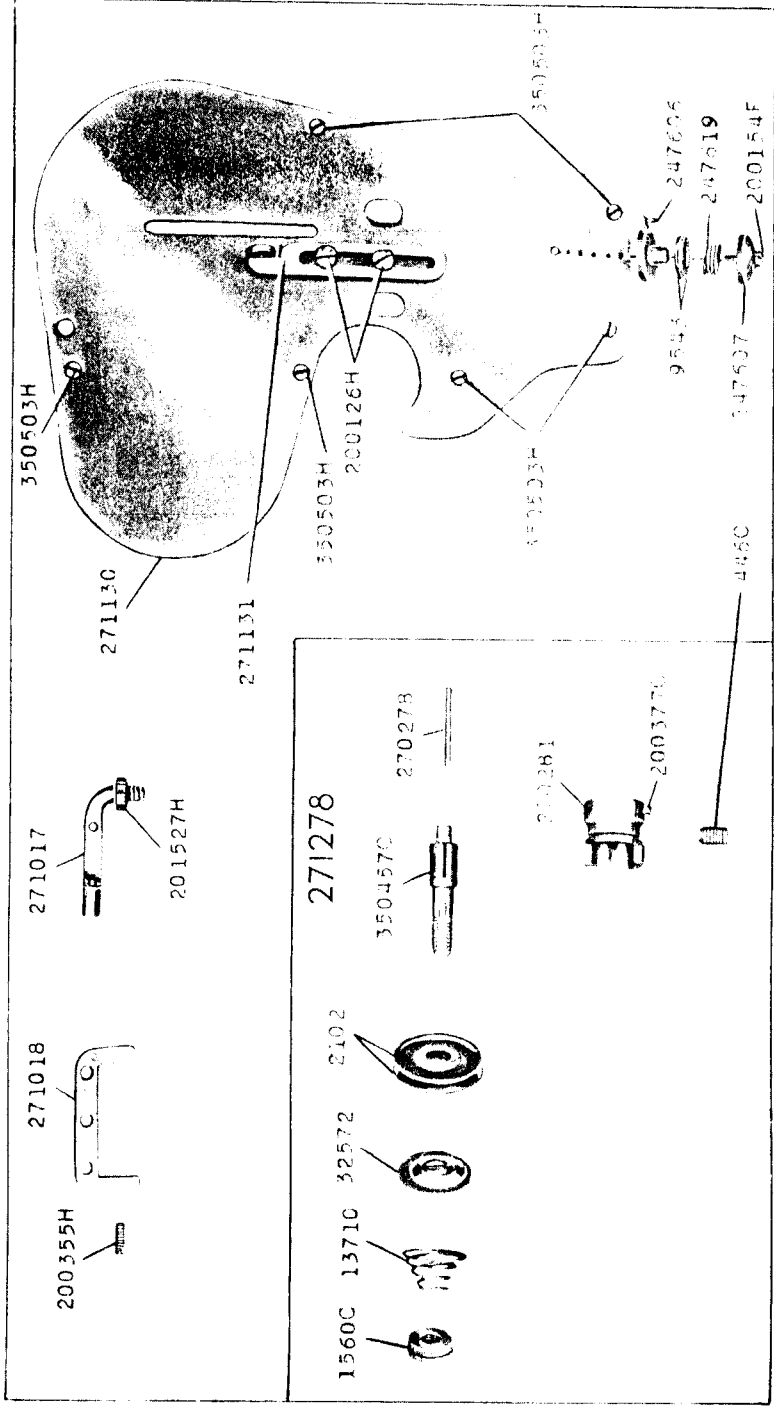

18460 - 3/8

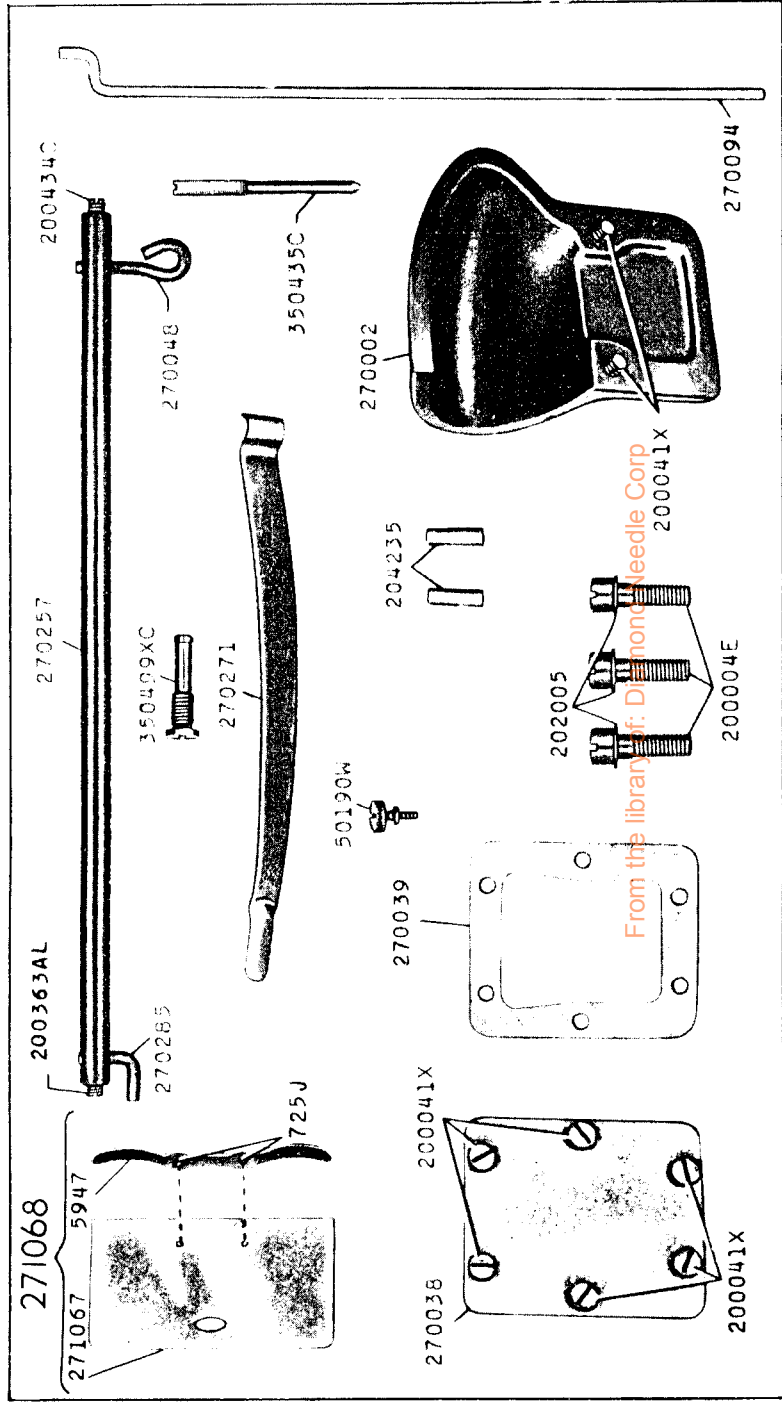

18461 - 3/8

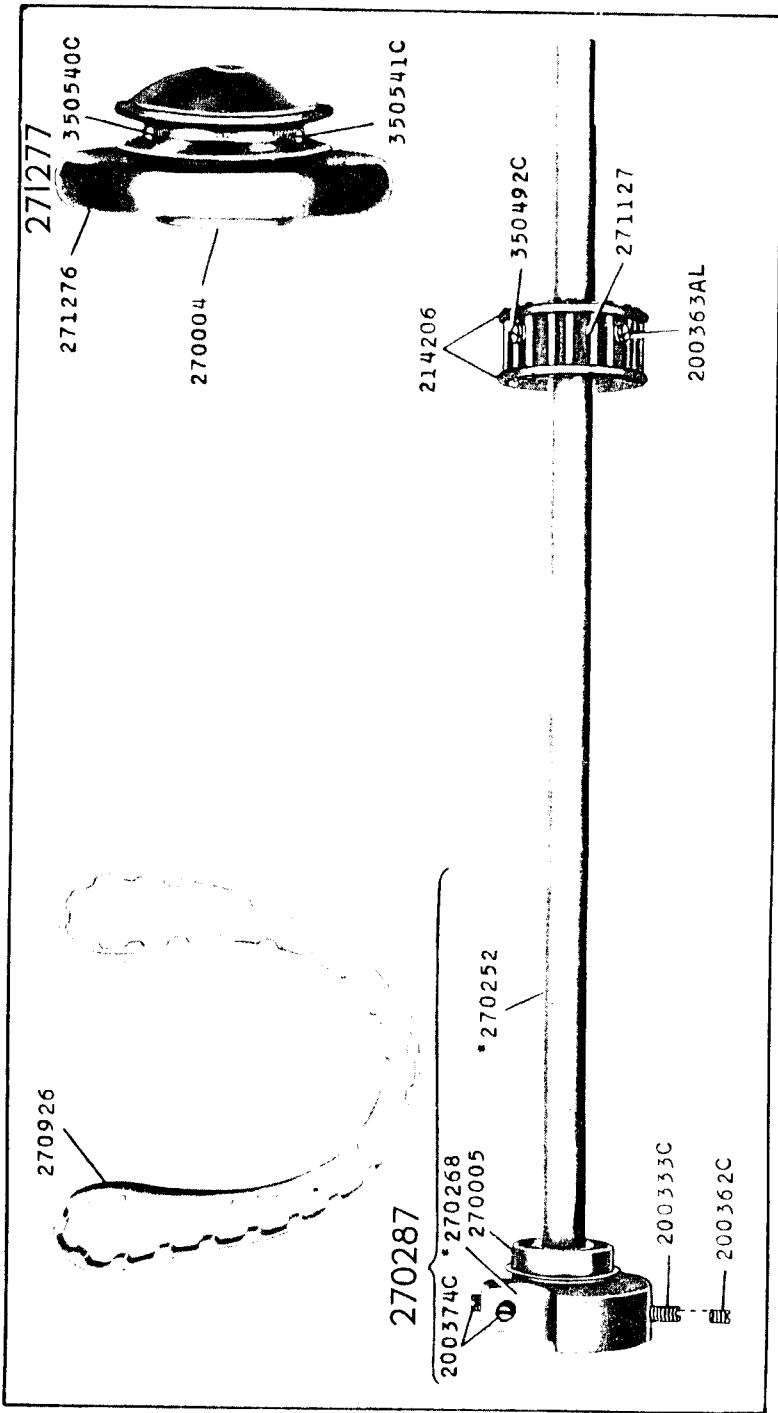

18462 - 1/2

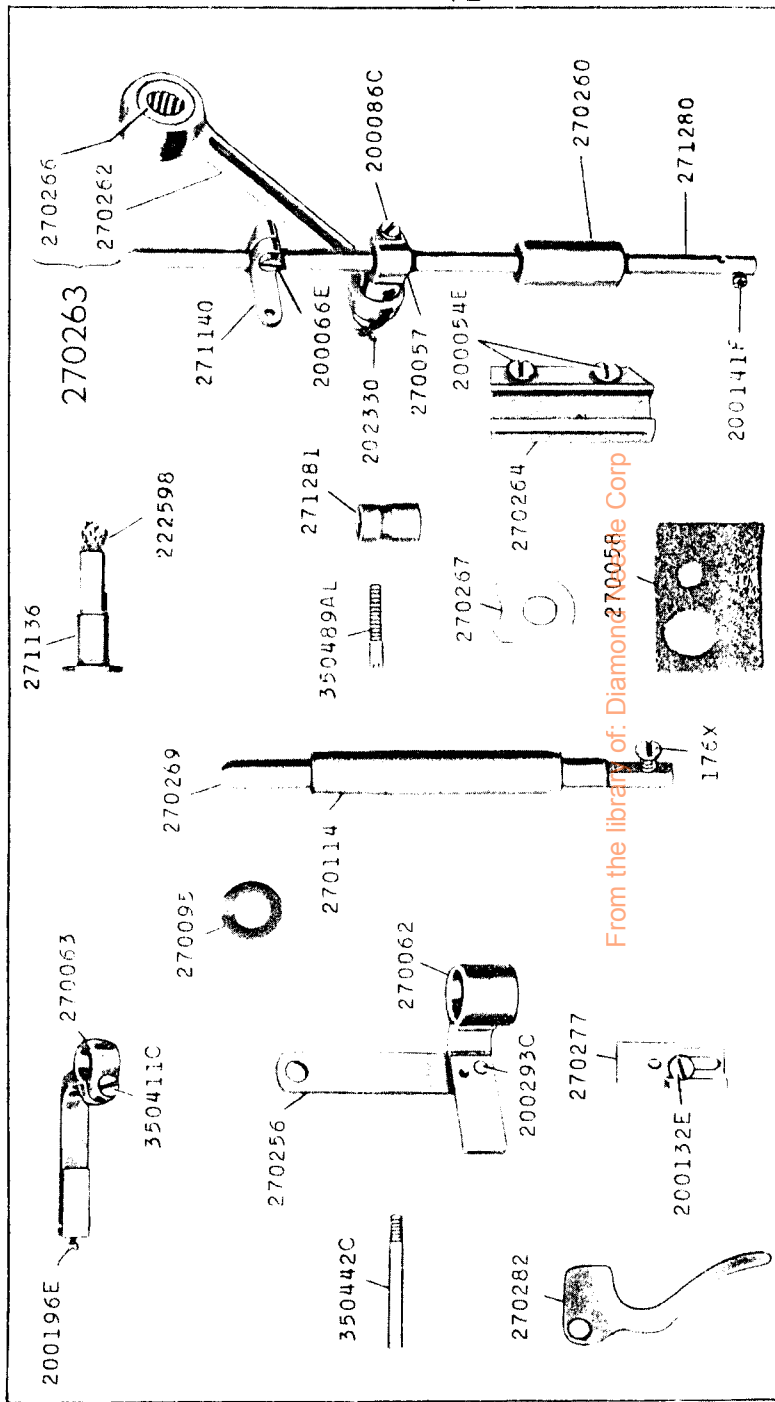

From the library of: Diamond 270058e Corp

